



Thermocouple

ASTC-H

Thermocouple ASTC-H

- Single or Double Thermocouple
- Type K, J, T, N, E, B, R, S
- Tolerance class 1 or 2 as IEC584, ANSI MC 96.1 Standard or Special
- Hot Joint: insulated, grounded
- Oxide Mineral execution (MgO)
- Diameters from 3mm to 8mm (others on request)
- Sheath in AISI316, Inconel600 (Aisi 304,310, 321 on request)
- Sheath length on request
- Aluminum Head connection
- Inner connection with ceramic block or temperature transmitter 4/20 mA output
- Fix or sliding compression fittings in AISI
- DIN BAR Transmitter
- Option of plate for contact measuring

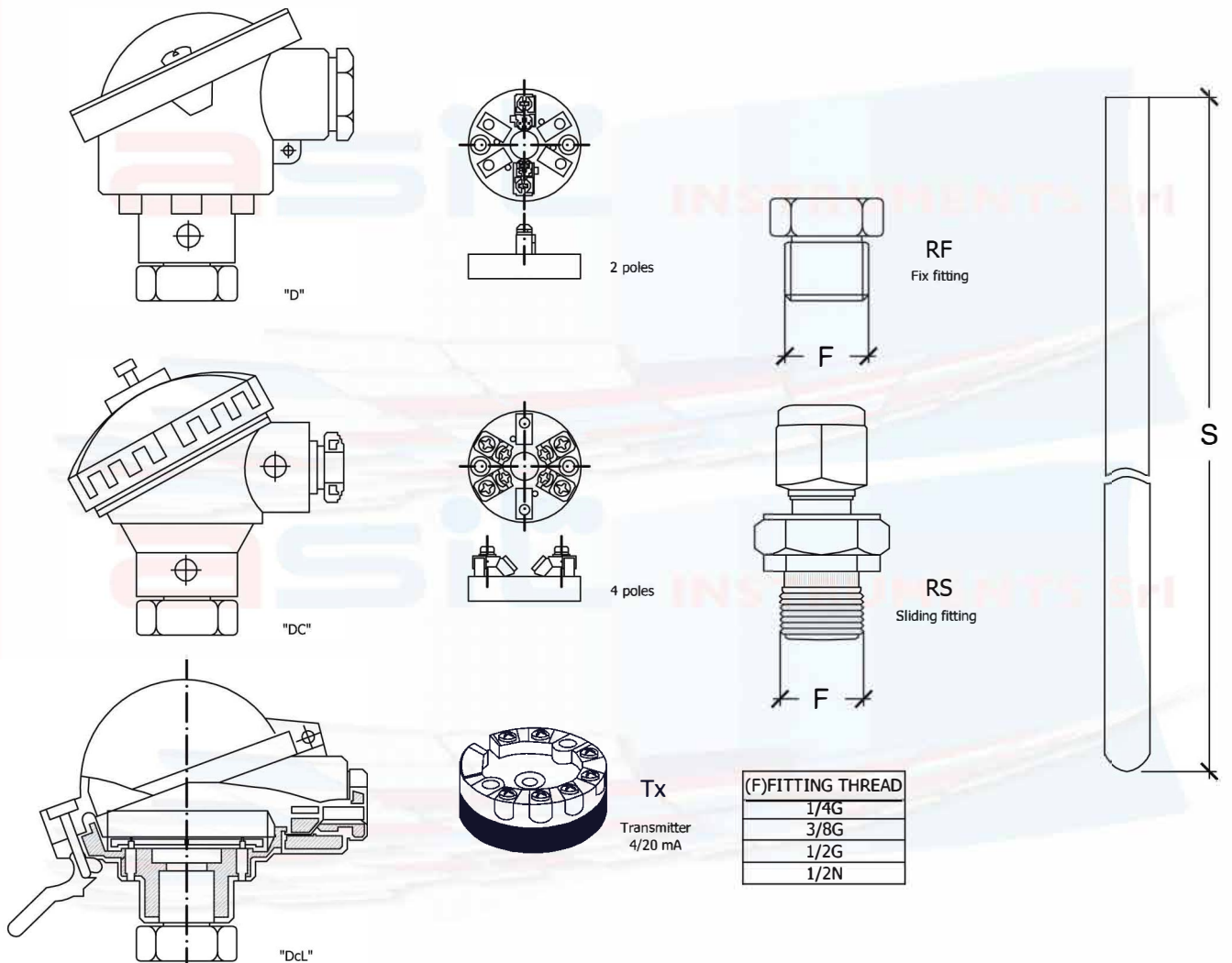
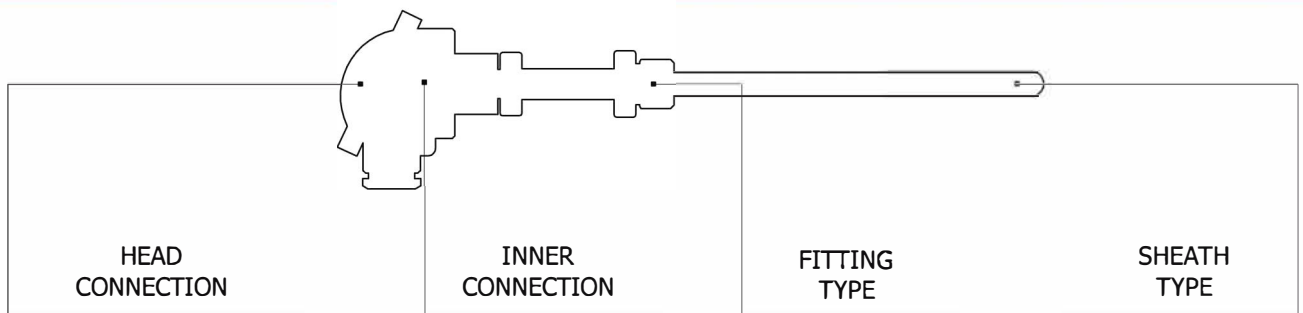

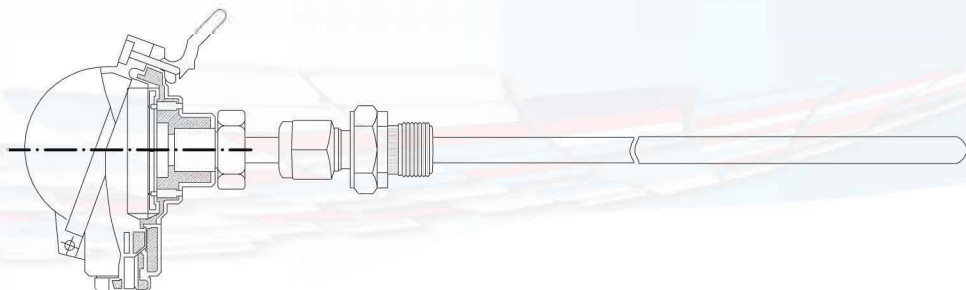
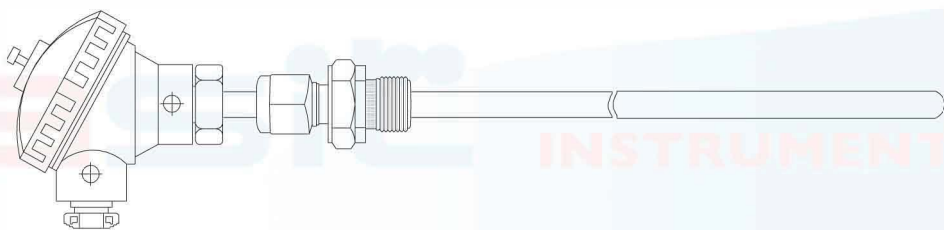
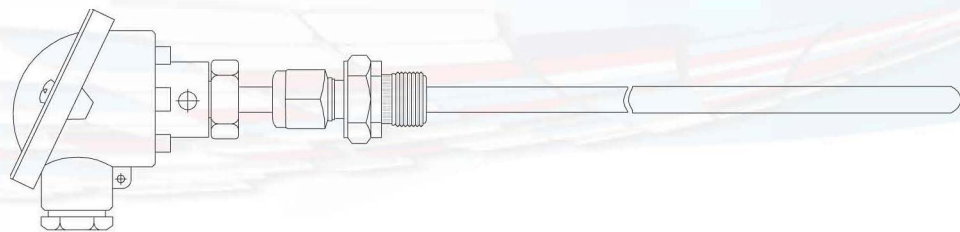
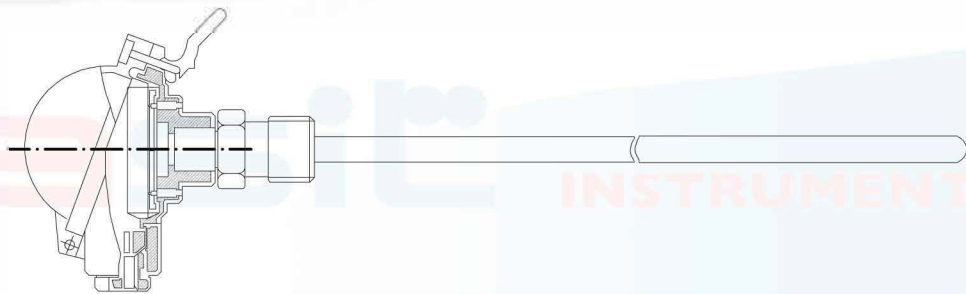
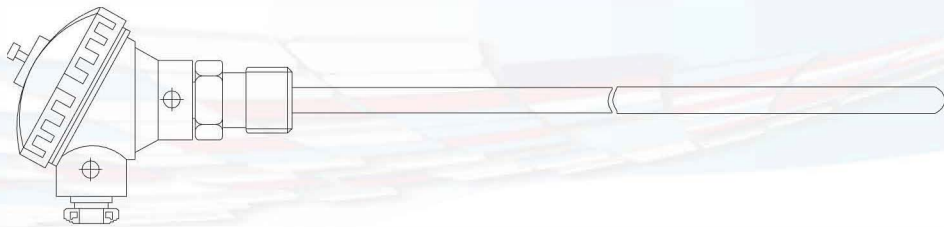

asit
INSTRUMENTS Srl